

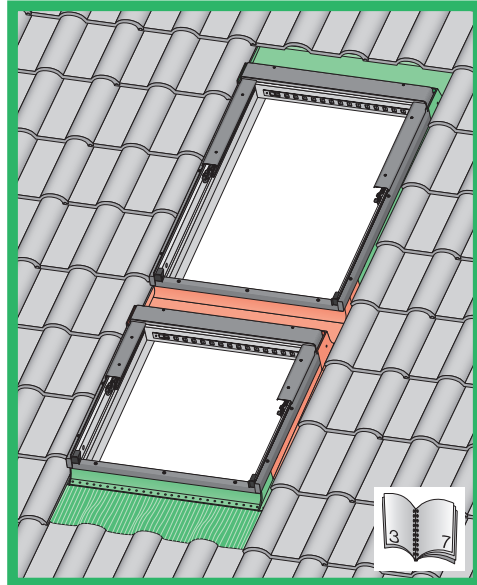

B1/2 E..+KD..

EHN+KDN



max 90mm

max 45mm

EZN+KDN, EZV+KDV, EZJ+KDJ

ELN+KDN, ELV+KDV, ELJ+KDJ

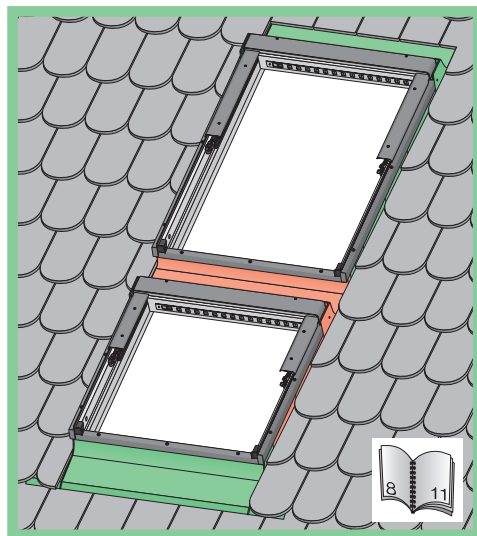

max 15mm (N)
max 5mm (V)
max 5mm (J)

ESN+KDN, ESV+KDV, ESJ+KDJ

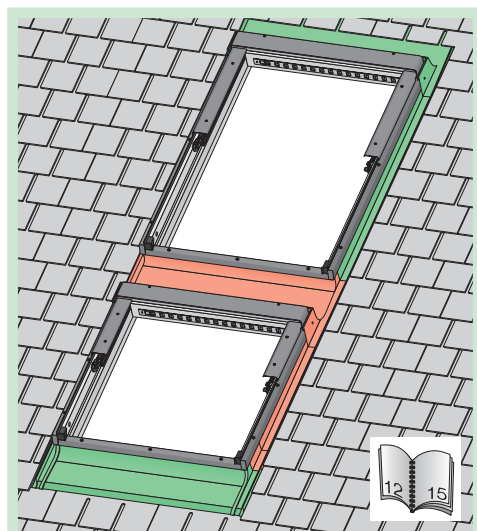

max 5mm

NC 245

| | | | |
|-----------------|-----------------------------------|---|----------------|
| <p>max 90mm</p> | <p>EHN +KDN</p> | | <p>15°-90°</p> |
| | <p>EHV +KDV</p> | | <p>15°-90°</p> |
| | - | - | - |

| | | | |
|-----------------|-----------------------------------|--|----------------|
| <p>max 45mm</p> | <p>EZN +KDN</p> | | <p>15°-90°</p> |
| | <p>EZV +KDV</p> | | <p>15°-90°</p> |
| | <p>EZJ +KDJ</p> | | <p>20°-90°</p> |

| | | | |
|---|-----------------------------------|--|----------------|
| <p>max 15mm (N) max 5mm (V) max 5mm (J)</p> | <p>ELN +KDN</p> | | <p>15°-90°</p> |
| | <p>ELV +KDV</p> | | <p>15°-90°</p> |
| | <p>ELJ +KDJ</p> | | <p>20°-90°</p> |

| | | | |
|----------------|-----------------------------------|--|----------------|
| <p>max 5mm</p> | <p>ESN +KDN</p> | | <p>15°-90°</p> |
| | <p>ESV +KDV</p> | | <p>15°-90°</p> |
| | <p>ESJ +KDJ</p> | | <p>20°-90°</p> |

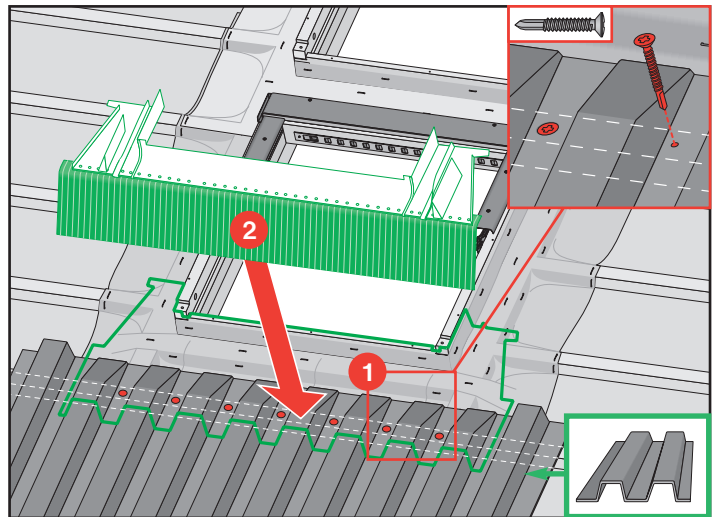
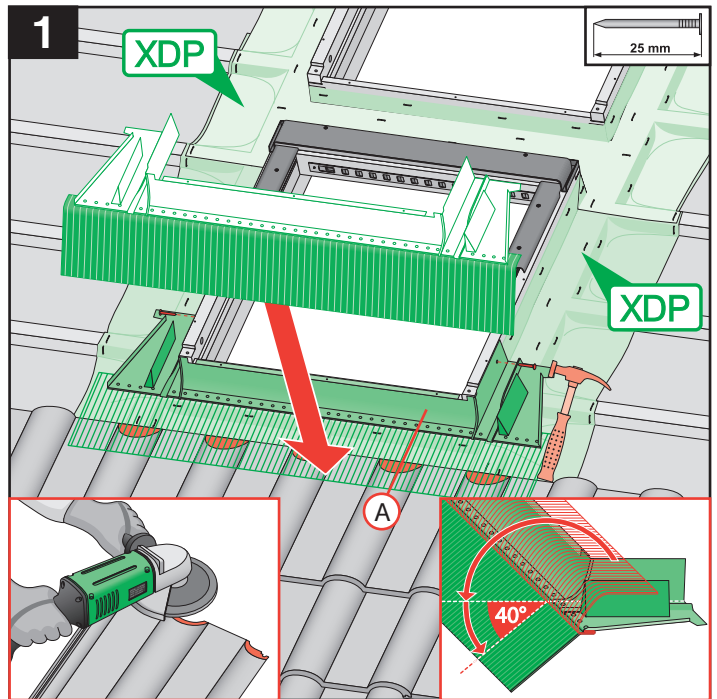
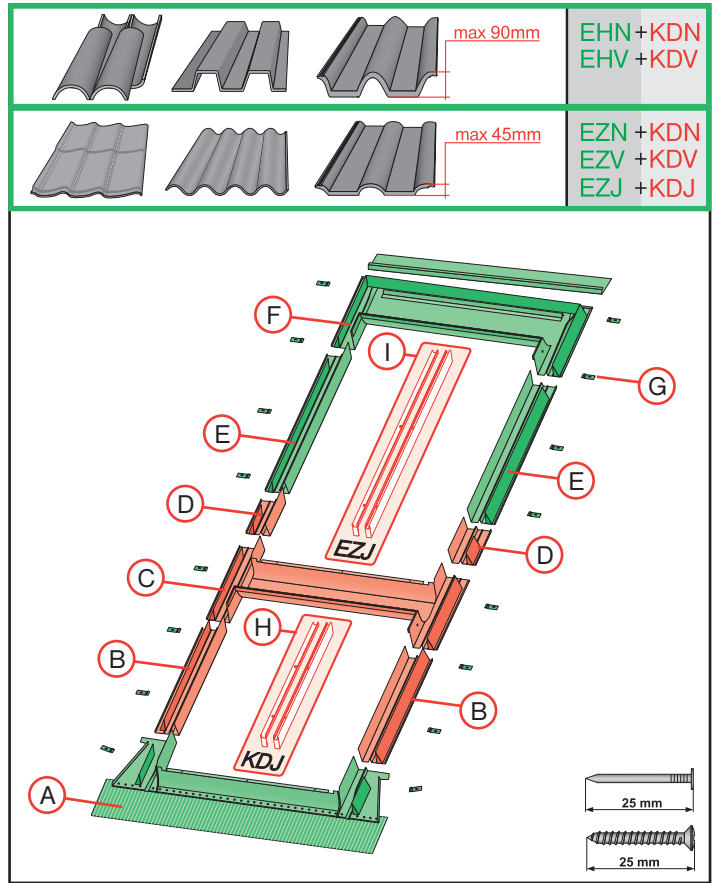

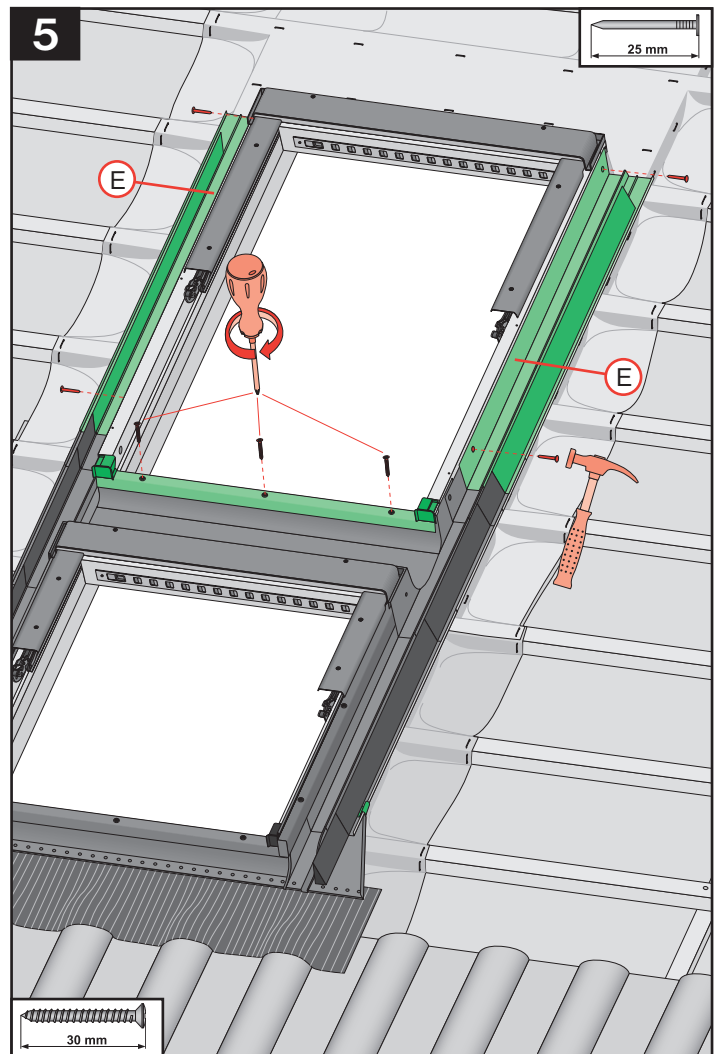
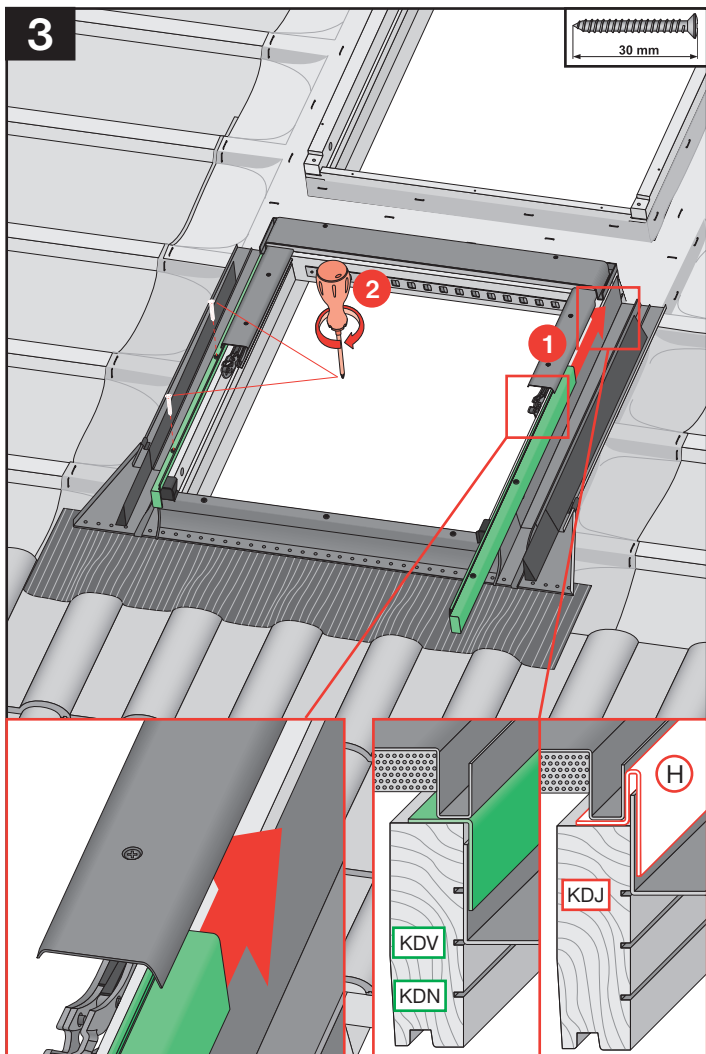
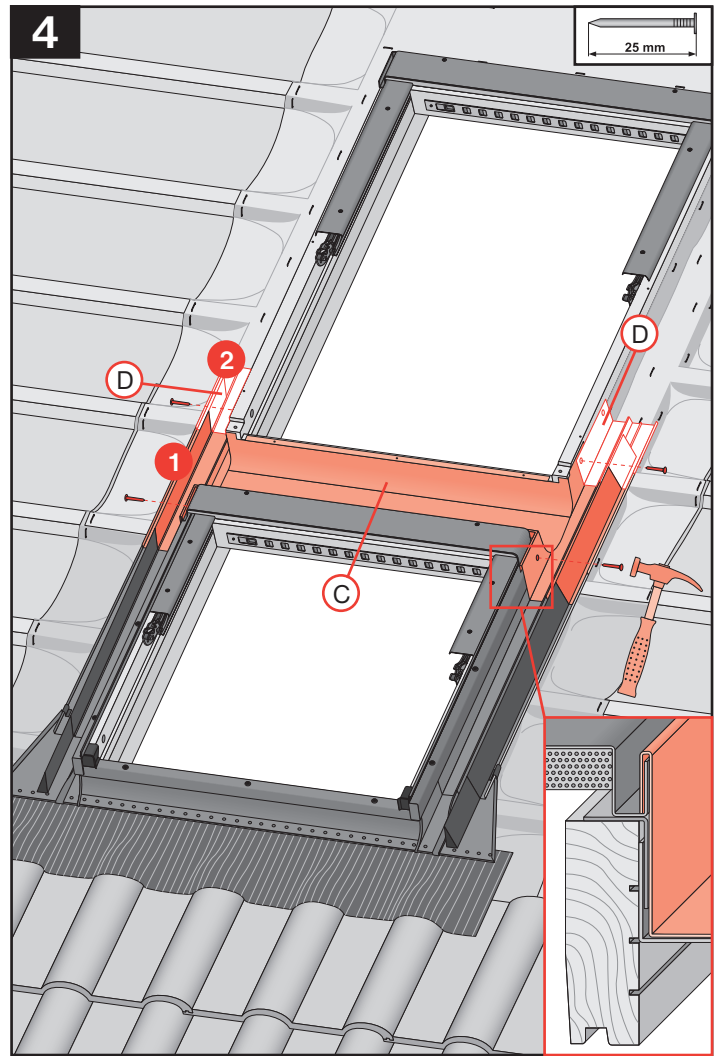
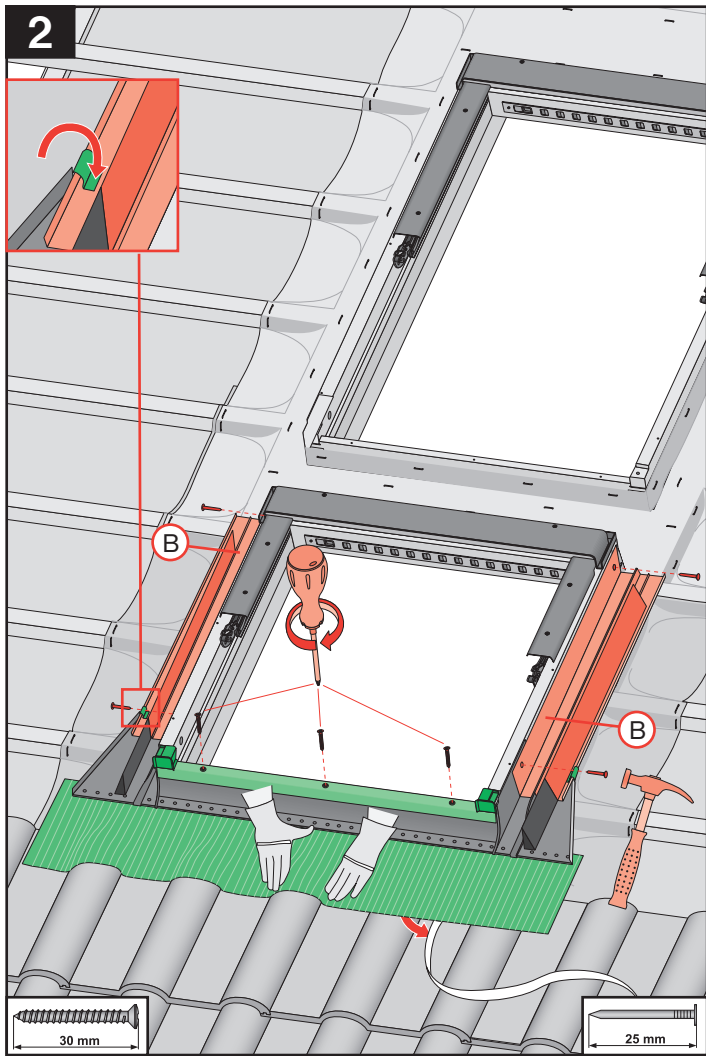

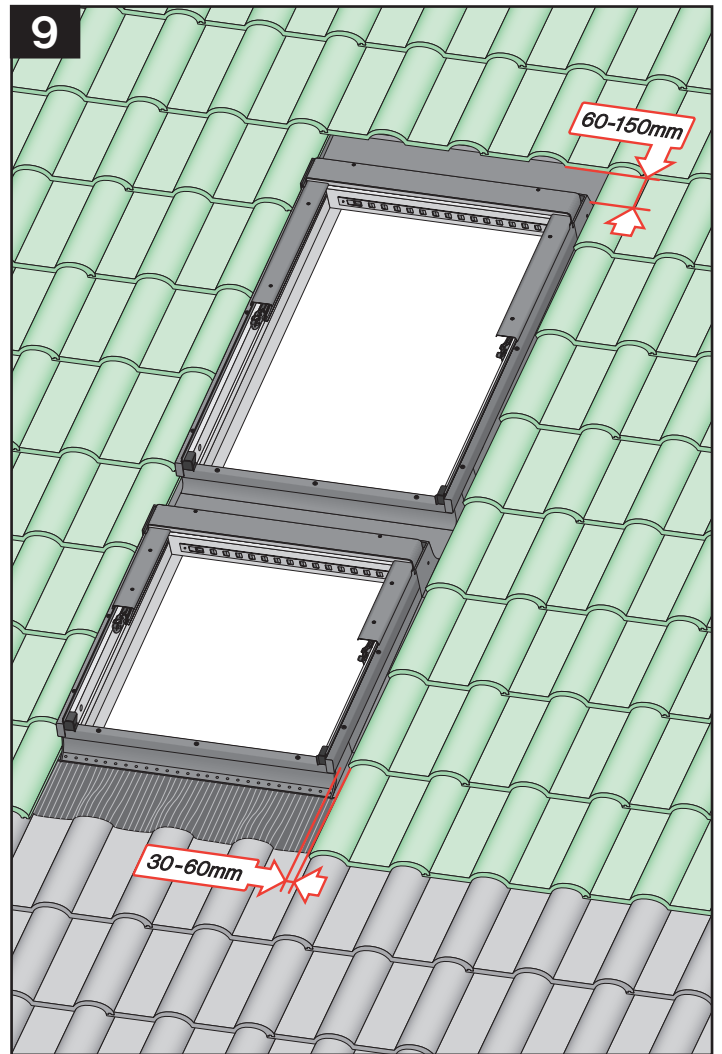
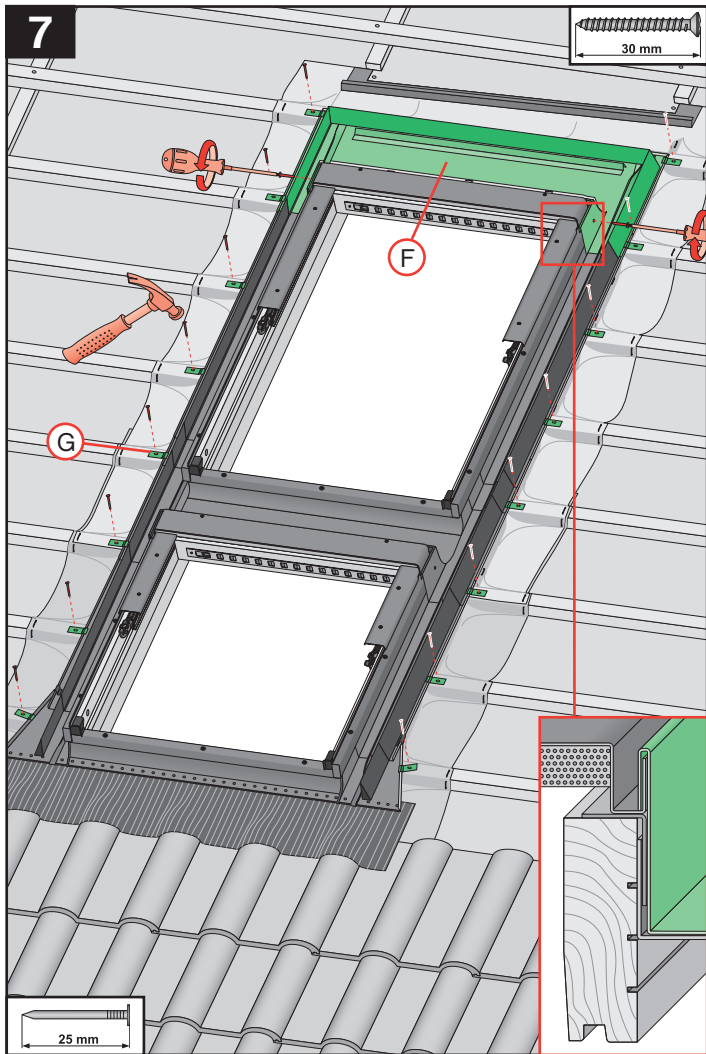
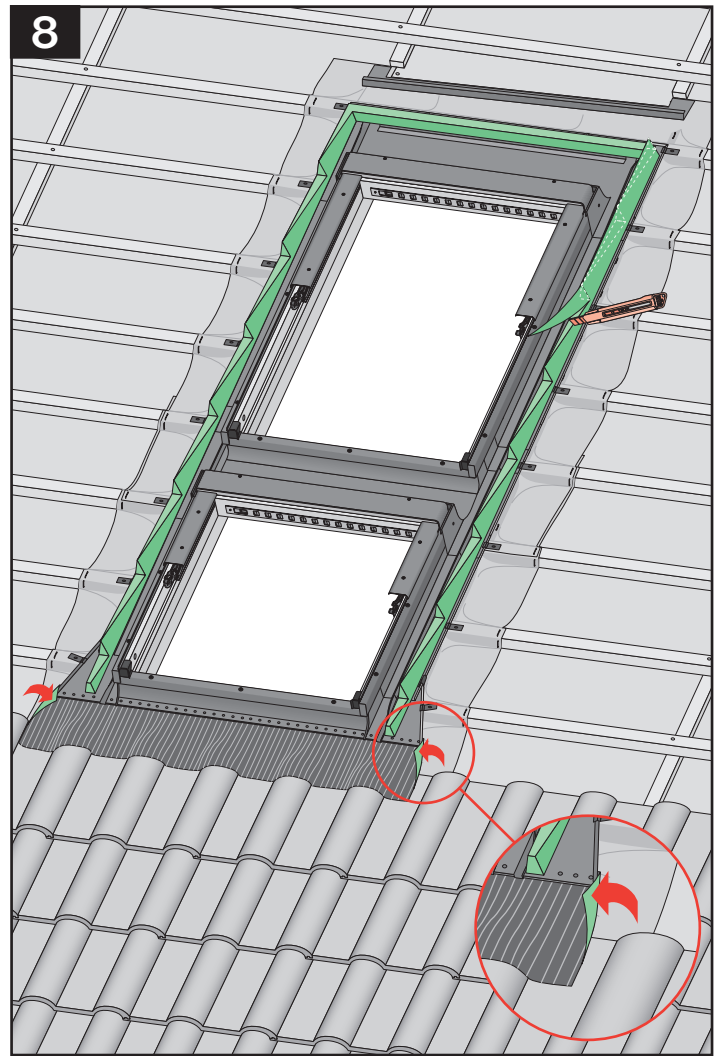
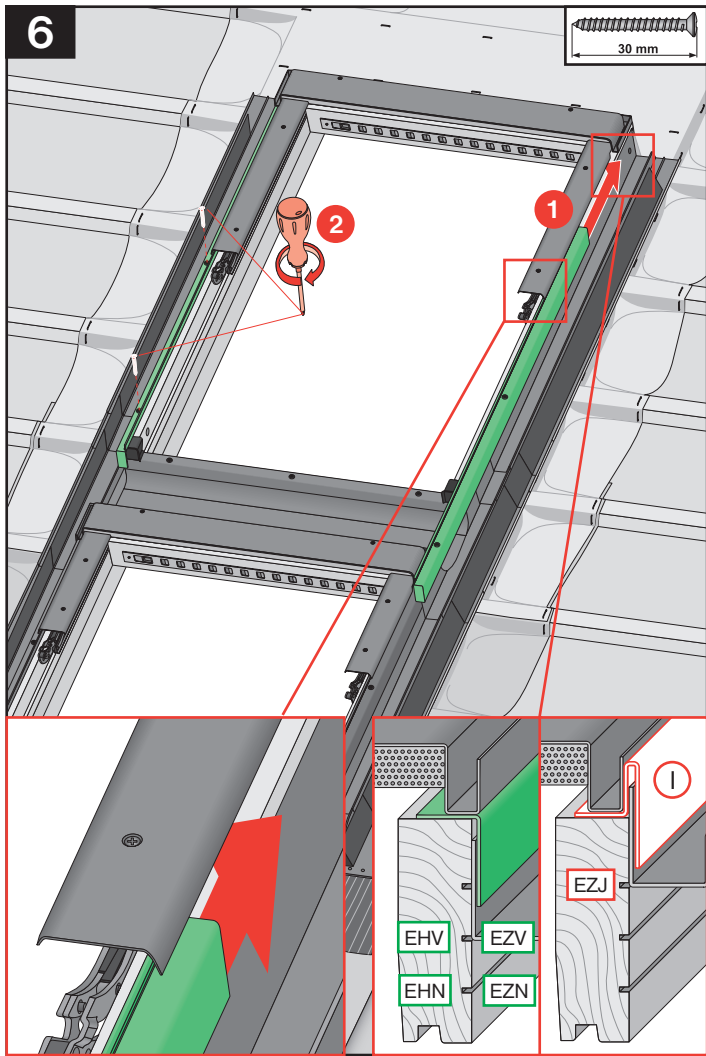

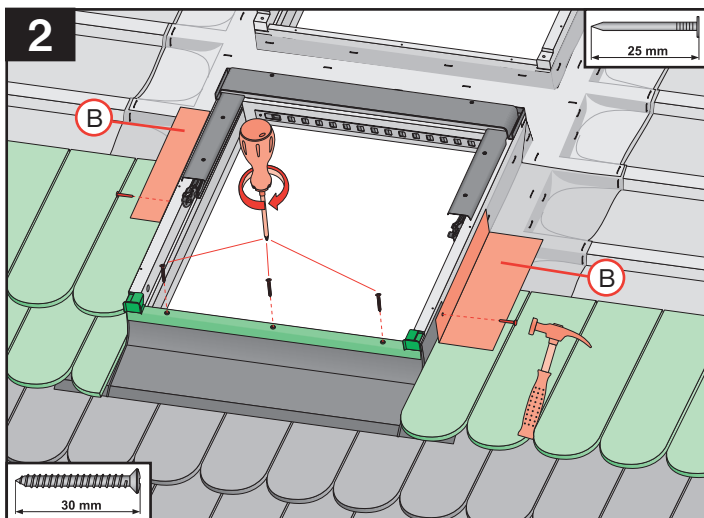
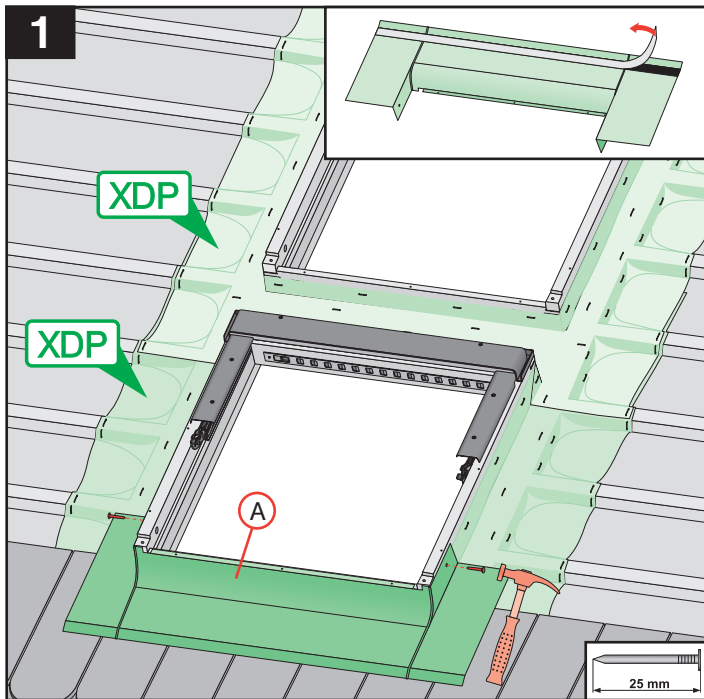
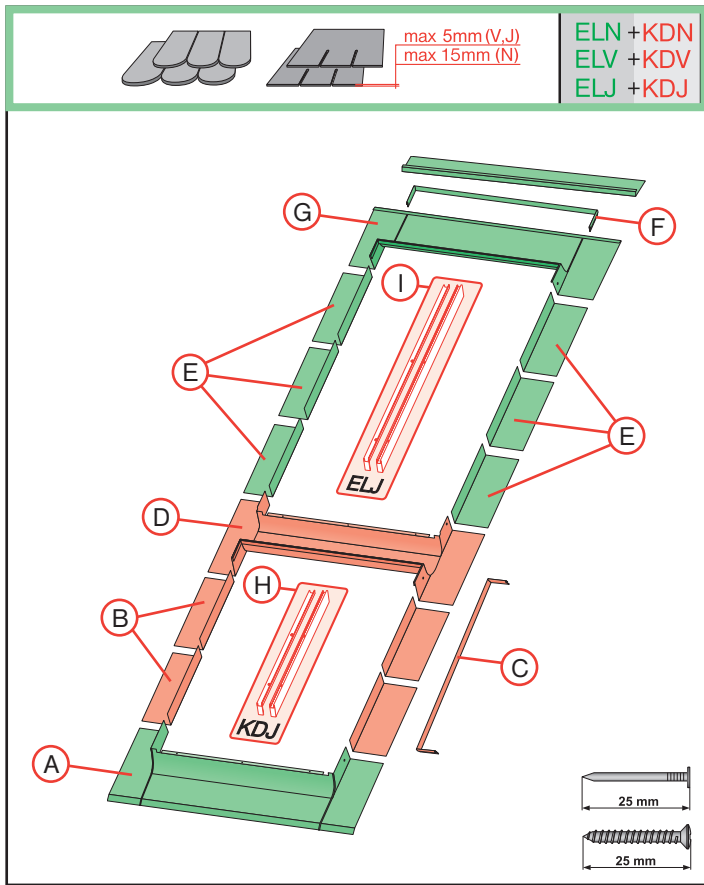

8

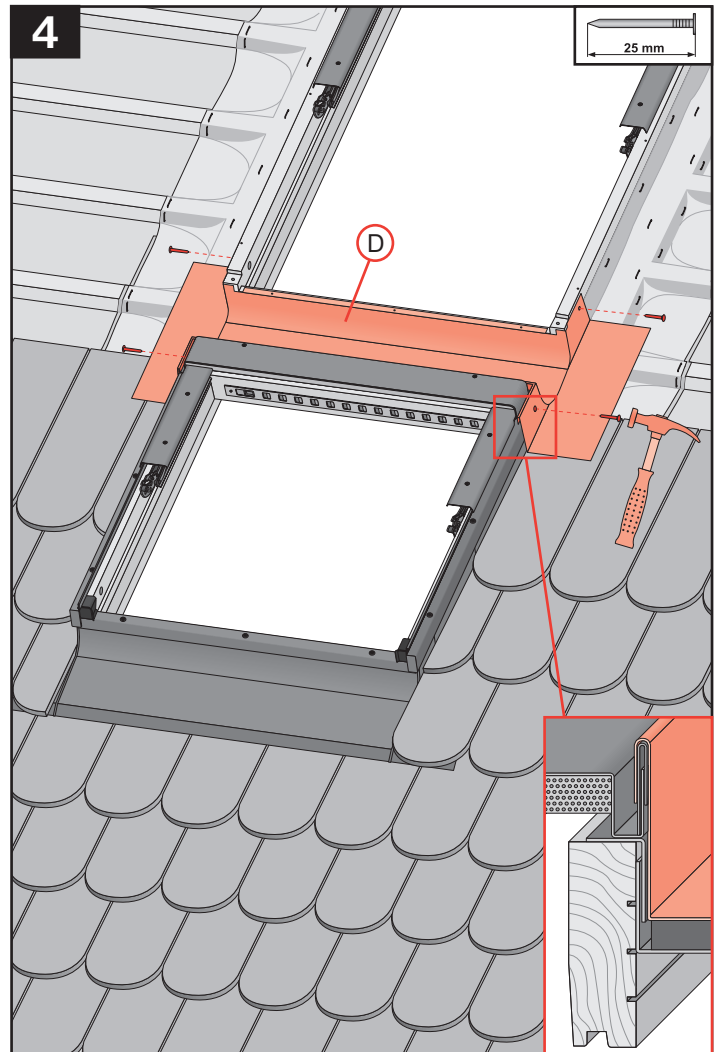
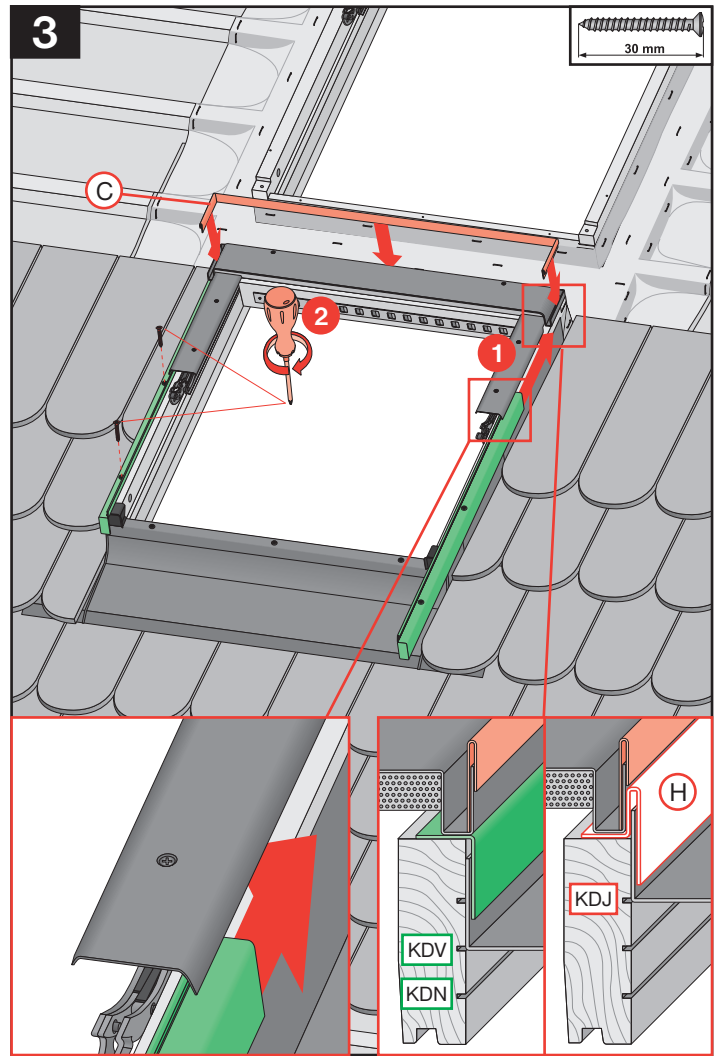

9

